

# parts catalogue



P4.17

P4.19

P4.42

Deze onderdelencatalogus bevat waardevolle informatie voor onderhoud en service aan uw motor.

Wij adviseren U, bij vervanging alleen originele 2  onderdelen toe te passen.

Het typeplaatje bevat informatie over de typeaanduiding, het motornummer en de serie.











Gebruik deze informatie bij bestelling van onderdelen.

This parts'catalogue contains valuable information for maintenance and service over your engine.

For replacement, we recommend that you use only genuine 2 parts. 

The identification tag contains information about model, serial number and series.

Use this information when ordering parts.

	<p><b>RESERVE KITS</b> <b>SPARE PARTS KIT</b></p>	<p><b>1</b></p>
	<p><b>MOTOR</b> <b>ENGINE</b></p>	<p><b>2</b></p>
	<p><b>KOELING</b> <b>COOLING</b></p>	<p><b>3</b></p>
	<p><b>ELECTRA, BEDIENING EN INSTRUMENTEN</b> <b>ELECTRICS, CONTROLS, INSTRUMENTS</b></p>	<p><b>4</b></p>
	<p><b>AANDRIJVING</b> <b>TRANSMISSION</b></p>	<p><b>5</b></p>
	<p><b>BRANDSTOFSYSTEEM</b> <b>FUEL SYSTEM</b></p>	<p><b>6</b></p>
	<p><b>GENERATOR</b> <b>GENERATOR</b></p>	<p><b>7</b></p>
	<p><b>GEREEDSCHAPPEN</b> <b>TOOLS</b></p>	<p><b>8</b></p>
	<p><b>ACCESSOIRES</b> <b>OPTIONALS</b></p>	<p><b>9</b></p>
	<p><b>ACCESSOIRES</b> <b>OPTIONALS</b></p>	<p><b>10</b></p>

# onderdelencatalogus parts catalogue



groep/ group	blz./ page	type	omschrijving/description	datum/date
1	1	P4.17 P4.19 P4.42	Kofferkit Case kit	20.6.98

pos.	qty	part	benaming	description
1	2	STM9185	Glaszekering 10A traag ø6,3x32	Glass fuse 10A slow ø6.3x32
2	1	STM9043	Relais 12V-70A.	Relay 12V-70A.
3	1	STM3366	Termostaat 83°C	Thermostat 83°C.
4	1	STM3365	Rubberring termostaat	Seal thermostat
5	1	STM6853	Pakking termostaat	Gasket for thermostat
6	2	STM6113	O-Ring ø61x2,5	O-Ring ø61x2.5
7	2	STM1007	Ring WW deksel	Washer heatex.cover
8	1	STM1062	Ring aftap WW	Washer drain heatex.
9	1	STM3690	Brandstoffilter	Fuelfilter
10	1	STM3797	Ring ontluchting br.filter	Washer(bleeding the fuelfilter)
11	1	STM4050	Brandstoffilter opvoerpomp	Fuelfilter lift pump
12	1	STM4037	Pakking	Gasket
13	1	STM4038	Pakking	Gasket
14	1	STM8003	Impeller	Impeller
15	1	STM8002	Pakking zeewaterpomp	Gasket seawater pump
16	1	STM9316	Oliefilter	Oilfilter
17	1	STM6528	Multy V riem 4PK715	Multy V belt 4PK715
18	2	STM3058	Slangklem 11-17	Hose clamp 11-17
19	2	STM2012	Slangklem 19-29	Hose clamp 19-29
20	2	STM3005	Slangklem 32-44	Hose clamp 32-44
21	4	STM6185	Klem brandstofslang	Clamp for fuel hose
22	1	STM0052	Busje verf 125cc	Can of paint 125cc
23	1	STM0062	Koffer geel	Case yellow
24	1	STM6567	Kofferkit compleet	Case kit cpl.

onderdelencatalogus  
parts catalogue



groep/ group	blz./ page	type	omschrijving/description	datum/date
-----------------	---------------	------	--------------------------	------------

--	--	--	--	--

# onderdelencatalogus parts catalogue



groep/ group	blz./ page	type	omschrijving/description	datum/date
2	1	P4.17 P4.17	Motorblok Engine block	07.02.'01

pos.	qty	part	benaming	description
1	4	STM6633	Pen	Pin
2	2	STM6618	Plug	Plug
3	8	STM6619	Plug	Plug
4	1	STM6620	Pen	Pin
5	1	STM6834	Afdichting	Washer
6	1	STM6621	Plug	Plug
7	1	STM6622	Pijp	Tube
8	1	STM6623	Afdichting	Washer
9	1	STM6624	Bout	Bolt
10	1	STM6625	Pakking	Gasket
11	1	STM6626	Deksel	Cover
12	2	STM6627	Sluitring	Washer
13	2	STM6628	Bout	Bolt
14	2	STM6629	Pen	Pin
15	2	STM6630	Pen	Pin
16	10	STM6631	Bout	Bolt
17	1	STM6632	Plug	Plug
18	1	STM6634	Bus	Bush
19	1	STM6635	Set dichtingen	Set of gaskets
20	1	STM9316	Oliefilter	Oilfilter
21	1	STM6835	Draadbus oliefilter	Shaft oil filter
22	1	STM6603	Oliedrukschakelaar	Pressure switch
23	1	STM6617	Ring	Washer
24	1	STM6636	Peilstok	Gauge oil level
25	1	STM6637	Pijp	Tube
26	1	STM6638	Carter ontluchting	Oil bleeding
27	1	STM6639	Slang	Hose
28	1	STM6640	Slang	Hose
29	4	STM6641	Klem	Clamp
30	1	STM6642	Vuldop	Filler cap
31	1	STM6431	Motorblok P4.17	Engine block P4.17
	1	STM6432	Motorblok P4.19	Engine block P4.19

onderdelencatalogus  
parts catalogue



groep/ group	blz./ page	type	omschrijving/description	datum/date
-----------------	---------------	------	--------------------------	------------

--	--	--	--	--

# onderdelencatalogus parts catalogue



groep/ group	blz./ page	type	omschrijving/description	datum/date
	2	3	P4.17 Drijfstang, Zuigers, Veren	Rod, Pistons,

pos.	qty	part	benaming	description
1	1	STM6437	Drijfstang	Rod
2	4	STM6438	Bus	Bush
3	4	STM6417	Zuigerpen	Piston pin
4	8	STM6418	Seegerring	Circlip
5	8	STM6419	Bout	Bolt
6	4	STM6420	Lagerschaal $\varnothing$ 50	Bearing shell $\varnothing$ 50
	4	STM6421	Lagerschaal + 0,30	Bearing shell + 0.30
7	8	STM6444	Moer	Nut
		Standaard		
8	4	STM6445	Zuiger $\varnothing$ 79,930 $\pm$ 0,009	Piston $\varnothing$ 79.930 $\pm$ 0.009
9	4	STM6446	Olieschraapveer	Scraper ring
10	4	STM6447	Afdichtzuigerveer	Compression ring
11	4	STM6448	Bovenste zuigerveer	Top ring
		1e reparatie		
8	4	STM6450	Zuiger $\varnothing$ 80,130 $\pm$ 0,009	Piston $\varnothing$ 80.130 $\pm$ 0,009
9	4	STM6451	Olieschraapveer	Scraper ring
10	4	STM6452	Afdichtzuigerveer	Compression ring
11	4	STM6453	Bovenste zuigerveer	Top ring
12	4	STM6454	Set zuigerringen	Set piston springs
		2e reparatie		
8	4	STM6455	Zuiger $\varnothing$ 80,430 $\pm$ 0,009	Piston $\varnothing$ 80.430 $\pm$ 0,009
9	4	STM6456	Olieschraapveer	Scraper ring
10	4	STM6457	Afdichtzuigerveer	Compression ring
11	4	STM6458	Bovenste zuigerveer	Top ring
12	4	STM6459	Set zuigerringen	Set piston springs
		3e reparatie		
8	4	STM6460	Zuiger $\varnothing$ 80,730 $\pm$ 0,009	Piston $\varnothing$ 80.730 $\pm$ 0,009
9	4	STM6461	Olieschraapveer	Scraper ring
10	4	STM6462	Afdichtzuigerveer	Compression ring
11	4	STM6463	Bovenste zuigerveer	Top ring
12	4	STM6464	Set zuigerringen	Set piston springs



onderdelencatalogus  
parts catalogue



groep/ group	blz./ page	type	omschrijving/description	datum/date
-----------------	---------------	------	--------------------------	------------

--	--	--	--	--

# onderdelencatalogus parts catalogue



groep/ group	blz./ page	type	omschrijving/description	datum/date
	2	3A	P4.19 Drijfstang, Zuigers, Veren	Rod, Pistons,

pos.	qty	part	benaming	description
1	1	STM6437	Drijfstang	Rod
2	4	STM6438	Bus	Bush
3	4	STM6416	Zuigerpen	Piston pin
4	8	STM6418	Seegerring	Circlip
5	8	STM6419	Bout	Bolt
6	4	STM6420	Lagerschaal $\varnothing$ 50	Bearing shell $\varnothing$ 50
	4	STM6421	Lagerschaal + 0,30	Bearing shell + 0.30
7	8	STM6444	Moer	Nut
		Standaard		
8	4	STM6465	Zuiger $\varnothing$ 82,930 $\pm$ 0,009	Piston $\varnothing$ 82.930 $\pm$ 0.009
9	4	STM6466	Olieschraapveer	Scraper ring
10	4	STM6467	Afdichtzuigerveer	Compression ring
11	4	STM6468	Bovenste zuigerveer	Top ring
		1e reparatie		
8	4	STM6470	Zuiger $\varnothing$ 83,130 $\pm$ 0,009	Piston $\varnothing$ 83.130 $\pm$ 0.009
9	4	STM6471	Olieschraapveer	Scraper ring
10	4	STM6472	Afdichtzuigerveer	Compression ring
11	4	STM6473	Bovenste zuigerveer	Top ring
12	4	STM6474	Set zuigerringen	Set piston springs
		2e reparatie		
8	4	STM6475	Zuiger $\varnothing$ 83,430 $\pm$ 0,009	Piston $\varnothing$ 83.430 $\pm$ 0.009
9	4	STM6476	Olieschraapveer	Scraper ring
10	4	STM6477	Afdichtzuigerveer	Compression ring
11	4	STM6478	Bovenste zuigerveer	Top ring
12	4	STM6479	Set zuigerringen	Set piston springs
		3e reparatie		
8	4	STM6480	Zuiger $\varnothing$ 83,730 $\pm$ 0,009	Piston $\varnothing$ 83.730 $\pm$ 0.009
9	4	STM6481	Olieschraapveer	Scraper ring
10	4	STM6482	Afdichtzuigerveer	Compression ring
11	4	STM6483	Bovenste zuigerveer	Top ring
12	4	STM6484	Set zuigerringen	Set piston springs

onderdelencatalogus  
parts catalogue



groep/ group	blz./ page	type	omschrijving/description	datum/date
-----------------	---------------	------	--------------------------	------------

--	--	--	--	--

# onderdelencatalogus parts catalogue



groep/ group	blz./ page	type	omschrijving/description	datum/date
	2	5	P4.17 P4.19 P4.42 Cilinderkop	Cylinderhead

pos.	qty	part	benaming	description
1	1	STM6715	Cilinderkop P4.19	Cylinder head P4.19
	1	STM6499	Cilinderkop P4.17	Cylinder head P4.17
2	1	STM6716	Cilinderkoppakking 1.61 P4.19/42	Cylinder head gasket 1.61 P4.19/42
	1	STM6717	Cilinderkoppakking 1.73 P4.19/42	Cylinder head gasket 1.73 P4.19/42
	1	STM6798	Cilinderkoppakking 1.61 P4.17	Cylinder head gasket 1.61 P4.17
	1	STM6797	Cilinderkoppakking 1.73 P4.17	Cylinder head gasket 1.73 P4.17
3	1	STM6718	Pakking	Gasket
4	1	STM6719	Deksel	Cover
5	2	STM6720	Bout	Bolt
6	2	STM6721	Sluitring	Washer
7	4	STM6888	Plug	Plug
8	1	STM6722	Plug	Plug
9	6	STM6723	Moer	Nut
10	6	STM6724	Sluitring	Washer
11	6	STM6725	Tapeind	Stud
12	10	STM6726	Bout	Bolt
13	10	STM6727	Sluitring	Washer
14	2	STM6728	Plug	Plug
15	2	STM6889	Plug	Plug
16	2	STM6729	Plug	Plug
17	1	STM6730	Pijp	Tube
18	4	STM6732	Turbulentiekamer ø 32,45 P4.19/42	Turbulence chamber ø 32.45 P4.19/42
	4	STM6733	Turbulentiekamer ø 32,65 P4.19/42	Turbulence chamber ø 32.65 P4.19/42
18	4	STM6899	Turbulentiekamer ø 32,45 P4.17	Turbulence chamber ø 32.45 P4.17
	4	STM6890	Turbulentiekamer ø 32,65 P4.17	Turbulence chamber ø 32.65 P4.17
19	4	STM6734	Klepgeleider ø 14,29	Valve guide ø 14.29
	4	STM6735	Klepgeleider ø 14,59	Valve guide ø 14.59
20	4	STM6736	Inlaatklepzitting	Inlet valve seat
	4	STM6737	Inlaatklepzitting	Inlet valve seat
21	4	STM6496	Uitlaatklepzitting ø 34,3	Exhaust valve seat ø 34.3
	4	STM6495	Uitlaatklepzitting ø 34,5	Exhaust valve seat ø 34.5
22	4	STM6739	Kogel	Ball
23	1	STM6614	Hijsoog	Lifting eye
24	1	STM6731	Pakkingset excl. koppakking P4.19/P4.42	Set of gaskets excl.head gasket P4.19/P4.42
	1	STM6399	Pakkingset excl. koppakking P4.17	Set of gaskets excl.head gasket P4.17

onderdelencatalogus  
parts catalogue



groep/ group	blz./ page	type	omschrijving/description	datum/date
	2	5	P4.17 P4.19 P4.42 Cilinderkop	Cylinderhead

# onderdelencatalogus parts catalogue



groep/ group	blz./ page	type	omschrijving/description	datum/date
3	1	P4.17 P4.19	Thermostaathuis- pompThermostat housing Cirulatie- circulating	pump

pos.	qty	part	benaming	description
1	1	STM6852	Deksel	Cover
2	1	STM6853	Pakking	Gasket
3	1	STM3365	Rubberring	Rubberring
4	1	STM3366	Thermostaat 83°C	Thermostat 83°C
5	1	STM6856	Segerring ø 72	Clips ø 72
6	1	STM6857	Thermostaathuis	Thermostathousing
7	1	STM6858	Pakking	Gasket
8	1	STM6604	Temperatuurgever	Thermistor
9	1	STM6605	Temperatuurschakelaar 97.5 °C	Temperature Switch 97.5 °C
10	2	STM6859	Bout M7 x 100-35	Bolt M7 x 100-35
11	2	STM6860	Bout M7 x 100-45	Bolt M7 x 100-45
12	2	STM6861	Bout	Bolt
13	2	STM6862	Ring	Washer
14	4	STM6863	Sluitring ø 7	Washer ø 7
15	1	STM6829	Cirulatie pomp	Circulating pump
16	1	STM6830	Pakking	Gasket
17	5	STM6831	Bout HRDL 7 x 100-20	Bolt HRDL 7 x 100-20

onderdelencatalogus  
parts catalogue



groep/ group	blz./ page	type	omschrijving/description	datum/date
-----------------	---------------	------	--------------------------	------------

--	--	--	--	--

# onderdelencatalogus parts catalogue



groep/ group	blz./ page	type	omschrijving/description	datum/date
	3 2	P4.17 P4.19 P4.42 Warmtewisse-	laarhuis Heatexchanger units	23.11.98

pos.	qty	part	benaming	description
1	1	STM6507	Warmtewisselaarhuis cpl.	Heatexchanger housing cpl.
2	1	STM6506	Warmtewisselaarhuis	Heatexchanger housing
3	1	STM1515	Vulnek	Filler neck
4	1	STM1017	Vuldop 0,5 bar	Filler cap 0.5 bar
5	1	STM4090	Tule	Tule
6	1	STM4087	Drukregelventiel	Pressure release valve
7	1	STM1062	Afdichtring	Seal washer
8	1	STM6511	Slangpilaar G1/4-8	Hose pillar G1/4-8
9	1	STM1062	Afdichtring	Seal washer
10	1	STM1059	Plug M14x1,5	Plug M14x1.5
11	1	STM6531	Logoplaatje	Logo plate
12	2	STM6113	O-Ring ø61x2,5	O-Ring ø61x2.5
13	1	STM6504	Deksel	Cover
14	2	STM1007	Afdichtring M8	Seal washer M8
15	2	STM1006	Inbusbout M8x30	Allen screw M8x30
16	1	STM3014	Pijpenbundel P4	Tube stack P4
17	1	STM6503	Deksel	Cover
18	7	STM1019	Gegolfde veerring M8	Wave spring washer M8
19	7	STM6430	Bout M8x114	Bolt M8x114
20	1	STM6130	Spanbus	Busching



onderdelencatalogus  
parts catalogue



groep/ group	blz./ page	type	omschrijving/description	datum/date
-----------------	---------------	------	--------------------------	------------

--	--	--	--	--

# onderdelencatalogus parts catalogue



groep/ group	blz./ page	type	omschrijving/description	datum/date
3	3	P4.17 P4.19 P4.42	Kielkoelspruitstuk Keelcooler manifold	23.11.98

pos.	qty	part	benaming	description
1	1	STM6509	Kielkoelspruitstuk cpl.	Keelcooler manifold cpl.
2	1	STM6508	Kielkoelspruitstuk	Keelcooler manifold
3	1	STM1515	Vulnek	Filler neck
4	1	STM9507	Vuldop "do not open"	Filler cap "do not open"
5	2	STM4043	Plug G1 1/2	Plug G1 1/2
6	1	STM4090	Tule	Tule
7	1	STM4087	Drukregelventiel	Pressure release valve
8	1	STM1062	Afdichtring	Seal washer
9	1	STM6511	Slangpilaar G1/4-8	Hose pillar G1/4-8
10	1	STM1062	Afdichtring	Seal washer
11	1	STM1059	Plug M14x1,5	Plug M14x1.5
12	1	STM6531	Logoplaatje	Logo plate
13	7	STM1019	Gegolfde veerring M8	Wave spring washer M8
14	7	STM6430	Bout M8x114	Bolt M8x114
15	1	STM9500	Expansietank cpl.	Expansiontank cpl.
16	1	STM9501	Expansietank	Expansiontank
17	1	STM9503	Slangklem	Hose clamp
18	1	STM9502	Bevestigingsbeugel	Support
19	2	STM9505	Slangklem	Hose clamp
20	1	STM9504	Slang l=1,5mtr.	Hose l=1.5mtr.

onderdelencatalogus  
parts catalogue



groep/ group	blz./ page	type	omschrijving/description	datum/date
-----------------	---------------	------	--------------------------	------------

--	--	--	--	--

# onderdelencatalogus parts catalogue



groep/ group	blz./ page	type	omschrijving/description	datum/date
	3 5	P4.17 P4.19 P4.42	Zeewaterpomp Seawater pump	20.6.98

pos.	qty	part	benaming	description
1	1	STM6514	Pomp (size 040)	Pump (size 040)
2	1	STM6512	Rubberbus	Inner sleeve
3	1	STM1056	Ring	Washer
4	1	STM6561	Bout M8x50	Bolt M8x50
5	1	STM6580	Slangpilaar G3/4-19	Hose pillar G3/4-19
6	2	STM6557	Ring	Washer
7	6	STM6584	Bout	Bolt
8	1	STM6585	Deksel	Cover
9	1	STM6586	Plug	Spline plug
10	1	STM8003	Impeller	Impeller
11	1	STM6588	Kam (full-cam)	Cam (full-cam)
12	1	STM6589	Huis	Body
13	1	STM6590	Schroef	Screw
14	1	STM6591	Slijtplaat	Wearplate
15	1	STM6592	Keerring	Lip seal
16	1	STM6593	As	Shaft
17	2	STM6594	Lager	Bearing
18	1	STM6595	Borgring	Retaining ring
19	1	STM6596	Borgring	Retaining ring
20	1	STM6597	Tapeind	Socket screw
21	1	STM8002	Pakking	Gasket
22	1	STM7014	Slangpilaar G3/4-25	Hose Pillar G3/4-25

onderdelencatalogus  
parts catalogue



groep/ group	blz./ page	type	omschrijving/description	datum/date
-----------------	---------------	------	--------------------------	------------

--	--	--	--	--

onderdelencatalogus  
parts catalogue



groep/ group 3	blz./ page 6	type P4.17 P4.19 P4.42	omschrijving/description Spruitstuk circulatiepomp Manifold for circulating pump	datum/date 07.02.'01
----------------------	--------------------	------------------------------	--	-------------------------

pos.	qty	part	benaming	description

onderdelencatalogus  
parts catalogue



groep/ group	blz./ page	type	omschrijving/description	datum/date
3	6	P4.17 P4.19 P4.42	Spruitstuk circulatiepomp Manifold for circulating pump	07.02.'01

# onderdelencatalogus parts catalogue



groep/ group	blz./ page	type	omschrijving/description	datum/date
3	7	P4.17 P4.19 P4.42	Slangen Hoses	20.6.98

pos.	qty	part	benaming	description
1	1	STM2011	Slang pomp-ww	Hose pump-heatexchanger housing
2	1	STM6550	Slang ww-uitlaatspruitstuk	Hose heatexch.-exhaust manifold
3	1	STM6551	Slang thermostaathuis-ww	Hose thermostathousing-heatexch
4	1	STM6552	Slang ww-circulatiepomp	Hose heatex.housing-cir.pump
5	1	STM6553	Slang thermostaathuis- circulatiepomp	Hose thermostathousing- circulating pump
6	1	STM6554	Slang cilinderkop-cir.pomp	Hosecilinderhead-circulating pump
7	1	STM6555	Slang ontluchting	Hose degassing
8	1	STM6556	Slang carter ontluchting	Hose cranke case ventilation
9	1	STM1027	Slang vulnek	Hose filler neck
10	1	STM6538	Smoring	Restrictor
12	3	STM3056	Slangklem 11-17	Hoseclamp 11-17
13	11	STM2012	Slangklem 19-29	Hoseclamp 19-29
14	2	STM3005	Slangklem 32-44	Hoseclamp 32-44
15	2	STM3012	Slangklem 38-50	Hoseclamp 38-50
16	1	STM6510	Steun	Support
17	2	STM3463	Leidingklem ø 27	Pipe clamp ø 27
18	3	STM1024	Bout M6x15	Bolt M6x15
19	3	STM1025	Veerring M6	Spring washer M6



onderdelencatalogus  
parts catalogue



groep/ group	blz./ page	type	omschrijving/description	datum/date
-----------------	---------------	------	--------------------------	------------

--	--	--	--	--

# onderdelencatalogus parts catalogue



groep/ group	blz./ page	type	omschrijving/description	datum/date
4	1	P4.17 P4.19 P4.42	Bedradingskast Terminalbox	17.6.97

pos.	qty	part	benaming	description
1	1	STM6134	Bedradingsteun	Wiring support
2	1	STM6135	Deksel	Cover
3	1	STM6146	Afstandhouder l=74	Spacer l=74
4	3	STM1707	Ring M5	Washer M5
5	3	STM1705	Moer M5	Nut M5
6	1	STM1025	Gegolfde veerring M6	Wave spring washer M6
7	3	STM9063	Bout M5x10	Bolt M5x10
8	1	STM9184	Zekeringhouder	Fuse holder
9	1	STM9185	Zekering 10A.traag ø6,3x32	Fuse 10A.slow ø6.3x32
10	1	STM6426	Steun (bij vliegwielhuis STM6519)	Support with flywheel housing STM6519)
11	2	STM9043	Relais 12V-70A.	Relay 12V-70A.
12	4	STM4055	Bout M8x16	Bolt M8x16
13	2	STM1019	Gegolfde veerring M8	Wave spring washer M8
14	1	STM6541	Motorbedrading	Engine wiring loom
15	4	STM6145	Bout M3x16	Bolt M3x16
16	4	STM6143	Veerring M3	Spring washer M3
17	4	STM6144	Moer M3	Nut M3
18	1	STM6222	Tussenkabel 2 mtr. optie	Intermediate cable 2 mtr. option
	1	STM6223	Tussenkabel 4 mtr. std.	Intermediate cable 4 mtr. std.
	1	STM6224	Tussenkabel 6 mtr. optie	Intermediate cable 6 mtr. option
	1	STM6225	Tussenkabe 12 mtr. optie	Intermediate cable 12 mtr. option
19	1	STM6548	T-stuk compleet	T-connector cpl.
20	1	STM9050	Relais 12V-30A.	Relay 12V-30A.
21	4	STM6549	Plaatschroef	Screw
22	1	STM6496	Bout M3x8	Bolt M3x8
23	1	STM6143	Veerring M3	Spring washer M3
24	1	STM6144	Moer M3	Nut M3
25	2	STM2005	Moer M8	Nut M8

onderdelencatalogus  
parts catalogue



groep/ group	blz./ page	type	omschrijving/description	datum/date
-----------------	---------------	------	--------------------------	------------

--	--	--	--	--

# onderdelencatalogus parts catalogue



groep/ group	blz./ page	type	omschrijving/description	datum/date
4	3	MPR2212	Instrumenten paneel 12V Instrument panel 12V	8.9.97

pos.	qty	part	benaming	description
1	1	STM9186	Paneel+frontfolie	Panel incl.overlay
2	1	STM9168	Print cpl.	Print cpl.
3	4	P2295RKP	Plaatschroef	Screw
4	6	STM9169	Gloeilamp	Bulb
5	1	STM9170	Pakking	Gasket
6	1	STM9171	Pakking	Gasket
7	1	STM9172	Pakking	Gasket
8	1	STM6573	Toeren/urenteller P4.17/P4.19	Tachometer/hourcounter P4.17/P4.19
	1	STM9047	Toeren/urenteller P4.42/P4.51/P4.56	Tachometer/hourcounter P4.42/P4.51/P4.56
9	1	STM9177	Voltmeter	Voltmeter
10	6	PA6480	Beugel	Support
11	6	P35164RKP	Plaatschroef	Screw
13	1	STM6204	Kabelboom	Wiring
14	1	STM9180	Pakking	Gasket
15	4	P352542KP	Plaatschroef	Screw
16	2	CT40131	Gloeilamp	Bulb
17	1	CT40133	Gloeilamp	Bulb
18	1	STM6572	Instr.paneel cpl. P4.17/P4.19	Instr.panel cpl. P4.17/P4.19
	1	STM6415	Instr.paneel cpl. P4.42/P4.51/P4.56	Instr.panel cpl. P4.42/P4.51/P4.56
19	1	STM9188	Contactslotdeksel	Key-switch cover
20	1	STM9214	Sleutel	Key
21	1	STM9215	Slot + sleutel	Lock + Key

onderdelencatalogus  
parts catalogue



groep/ group	blz./ page	type	omschrijving/description	datum/date
4	3	MPR2212 Instrumenten paneel 12V	Instrument panel 12V 8.9.97	

# onderdelencatalogus parts catalogue



groep/ group	blz./ page	type	omschrijving/description	datum/date
4	4	P4.17 P4.19 P4.42	Dynamo en Startmotor Alternator and starter motor	9.2.98

pos.	qty	part	benaming	description
1	1	STM6527	Dynamo 90 A.	Alternator 90 A.
2	1	STM6528	Multi V riem 4PK715	Multi V belt 4PK715
3	1	STM6607	Bout	Bolt
4	1	STM6566	Bus	Bushing
5	1	STM6534	Spansteun	Tension support
6	2	STM1056	Veerring M8	Spring washer M8
7	1	STM1610	Bout M8x25	Bolt M8x25
8	1	STM7059	Bout M8x30	Bolt M8x30
9	1	STM2005	Moer M8	Moer M8
10	1	STM6535	Spanmoer	Tension nut
11	1	STM3749	Ring M8	Washer M8
12	1	STM6533	Moer M8 nyloc	Nut M8 nyloc
13	1	STM1025	Gegolfde veerring M6	Wave spring washer M6
14	1	STM6536	Spanbout M6x70	Tension bolt M6x70
15	1	STM6576	Beschermkap	Cover
16	1	STM6423	Plakker P4.17	Sticker P4.17
	1	STM6577	Plakker P4.19	Sticker P4.19
	1	STM6407	Plakker P4.42	Sticker P4.42
17	1	STM6424	Beschermkap+plakker P4.17	Cover+Sticker P4.17
	1	STM6578	Beschermkap+plakker P4.19	Cover+sticker P4.19
	1	STM6408	Beschermkap+plakker P4.42	Cover+sticker P4.42
18	3	STM4016	Bout M10x20	Bolt M10x20
19	3	STM2022	Gegolfde veerring M10	Wave spring washer M10
20	1	STM6609	Startmotor	Starter motor
21	1	STM3453	Bus	Bushing
22	1	STM6560	Bout M10x50	Bolt M10x50
23	3	STM2022	Gegolfde veerring M10	Gegolfde veerring M10
24	2	STM4062	Bout M10x40	Bolt M10x40

onderdelencatalogus  
parts catalogue



groep/ group	blz./ page	type	omschrijving/description	datum/date
-----------------	---------------	------	--------------------------	------------

--	--	--	--	--

# onderdelencatalogus parts catalogue



groep/ group 4	blz./ page 5	type P4.17 P4.19 P4.42	omschrijving/description Zenders Sender units	datum/date 20.6.98
----------------------	--------------------	------------------------------	---	-----------------------

pos.	qty	part	benaming	description
1	1	STM6600	Stopmagneet	Stop solenoid
2	4	STM6601	Gloeibougie	Glow plug
3	1	STM6602	Draad	Wire
4	1	STM6603	Oliedrukschakelaar M16x1,5	Oil pressure switch M16x1.5
5	1	STM6604	Temperatuurgever M14x1,5	Temperature sending unit M14x1.5
6	1	STM6605	Temp.schakelaar 97,5°C M14x1,25	Temp.switch 97.5°C M14x1.25
7	1	STM2195	Temp.schakelaar 93°C M18x1,5	Temp.switch 93°C M18x1.5
8	1	STM6612	Ring	Washer
9	1	STM6613	Ring	Washer
10	1	STM6614	Moer	Nut
11	4	STM6615	Ring	Washer
12	4	STM6616	Moer	Nut
13	1	STM6617	Afdichtring M16	Seal washer M16
14	1	STM2019	Afdichtring M18	Afdichtring M18
15	1	STM6422	Adapter (optie)	Adaptor (option)
16	1	CT40083	Oliedrukgever M10x1k (optie)	Oilpressure sending unit(option)



onderdelencatalogus  
parts catalogue



groep/ group	blz./ page	type	omschrijving/description	datum/date
4	5	P4.17 P4.19 P4.42	Zenders Sender units	20.6.98

# onderdelencatalogus parts catalogue



groep/ group 4	blz./ page 6	type P4.17 P4.19 P4.42	omschrijving/description Bediening Controls	datum/date 20.6.98
----------------------	--------------------	------------------------------	---	-----------------------

pos.	qty	part	benaming	description
1	1	STM1703	Kabelklem	Cable clamp
2	2	STM1704	Bout M5x25	Bolt M5x25
3	3	STM1707	Ring M5	Washer M5
4	1	STM1806	Nippel	Nipple
5	1	STM1808	Splitpen 2x25	Split pin 2x25
6	1	STM1851	Steun Hurth HBW	Support Hurth HBW
	1	STM6425	Steun Hurth HSW125H	Support Hurth HSW125H
7	2	STM2005	Moer M8	Nut M8
9	2	STM1019	Gegolfde veerring M8	Wave spring washer M78
11	1	STM3767	Steun PRM	Support PRM
12	2	STM1705	Moer M5	Nut M5
13	2	STM1707	Ring M5	Washer M5
14	1	STM6574	Gaskabelsteun	Throttle support
15	1	STM9013	Bout M7x25	Bolt M7x25
16	1	STM1606	Gegolfde veerring M7	Wave spring washer M7
17	1	STM6575	Gaskabelnippel	Throttle nipple
18	1	STM1703	Kabelklem	Cable clamp
19	2	STM1704	Bout M5x25	Bolt M5x25
20	2	STM1707	Ring M5	Washer M5
21	2	STM1705	Moer M5	Nut M5
22	1	STM6886	Kabelklem	Cable clamp
23	2	STM6887	Moer M8	Nut M8
24	1	STM6888	Bout	Bolt
25	1	STM6889	Thermostaat	Thermostat
26	1	STM6890	Ring	Washer
27	1	STM6569	Veer	Spring
28	1	STM6568	Moer 10-32UNF	Nut 10-32UNF

onderdelencatalogus  
parts catalogue



groep/ group	blz./ page	type	omschrijving/description	datum/date
-----------------	---------------	------	--------------------------	------------

--	--	--	--	--

# onderdelencatalogus parts catalogue



groep/ group	blz./ page	type	omschrijving/description	datum/date
5	1	P4.17 P4.19 P4.42	Vliegwielhuis Hurth-PRM Flywheel housing Hurth-PRM	7.7.99

pos.	qty	part	benaming	description
1	1	STM6517	Vliegwielhuis HBW	Flywheel housing HBW
		STM6518	Vliegwielhuis PRM	Flywheel housing PRM
2	1	STM4104	Demperplaat HBW, Volvo 110S, 120S, 120 SB	Damper plate HBW, Volvo 110S, 120S, 120 SB
	1	STM6396	Demperplaat 7.99 => HSW125-PRM150	Damper plate 7.99 => HSW125-PRM150
		STM3759	Demperplaat PRM delta20-30	Damper plate PRM delta20-30
3	1	STM6505	Vliegwiel verzwaring	Flywheel ring
4	1	STM6521	Afdichtplaat	Cover
5	1	STM6520	Afdichtplaat	Cover
6	4	STM1025	Gegolfde veerring M6	Wave spring washer M6
7	4	STM1030	Bout M6x20	Bolt M6x20
8	6	STM1019	Gegolfde veerring M8	Wave spring washer M8
9	6	STM1610	Bout M8x25	Bolt M8x25
10	3	STM3452	Paspen 1/4"x5/8" ANSI B5.20	Pin 1/4"x5/8 ANSI B5.20
11	6	STM6539	Inbusbout M8x40	Allen Screw M8x40
12	3	STM6537	Paspen 6x20 DIN6325	Pin 6x20 DIN6325
13	6	STM1056	Veerring M8	Spring washer M8
14	6	STM6111	Inbusbout M8x16	Allen screw M8x16
15	4	STM4061	Gegolfde veerring M10	Wave spring washer M10
16	4	STM1612	Bout M10x100	Bolt M10x100
17	1	STM1054	Type plaatje	Model plate
18	2	STM3528	Kerfnagel 3x5 DIN1476	Pin 3x5 DIN1476
19	2	STM6611	Spanbus	Bush
20	1	STM5176	Peilstok HBW100	Dipstick HBW100
	1	STM5177	Peilstok HBW125-HBW150	Dipstick HBW125-HBW150
	1	STM3773	Peilstok PRM delta20-30	Dipstick PRM delta20-30
21	1	STM5171	Pakkingset HBW100	Gasket set HBW100
	1	STM5172	Pakkingset HBW150	Gasket set HBW150
22	4	STM4010	Moer M16x1,5	Nut M16x1.5
23	2	STM4011	Ring	Washer
24	2	KSTEUN75	Trillingdemper	Vibration damper
25	1	STM6201	O-Ring ø65x1,5	O-ring ø65x1.5
26	1	STM5102	Keerkoppeling HBW100-2R	Gearbox HBW100-2R
	1	STM5123	Keerkoppeling HBW125-2,5R	Gearbox HBW125-2.5R
	1	STM5162	Keerkoppeling HBW150V-2	Gearbox HBW150V-2
	1	STM5163	Keerkoppeling HBW150V-3	Gearbox HBW150V-3
	1	STM5154	Keerkoppeling HBW150A-2R	Gearbox HBW150A-2R
	1	CT50122	Keerkoppeling HSW125H 2,14:1	Gearbox HSW125H 2.14:1
	1	CT50123	Keerlappeling HSW125H 2,63:1	Gearbox HSW125H 2.63:1
27	1	STM3760	Keerkoppeling PRM delta20	Gearbox PRM delta20
	1	STM3758	Keerkoppeling PRM delta30	Gearbox PRM delta30

onderdelencatalogus  
parts catalogue



groep/ group	blz./ page	type	omschrijving/description	datum/date
5	1	P4.17 P4.19 P4.42	Vlieg wielhuis Hurth-PRM Flywheel housing Hurth-PRM	7.7.99

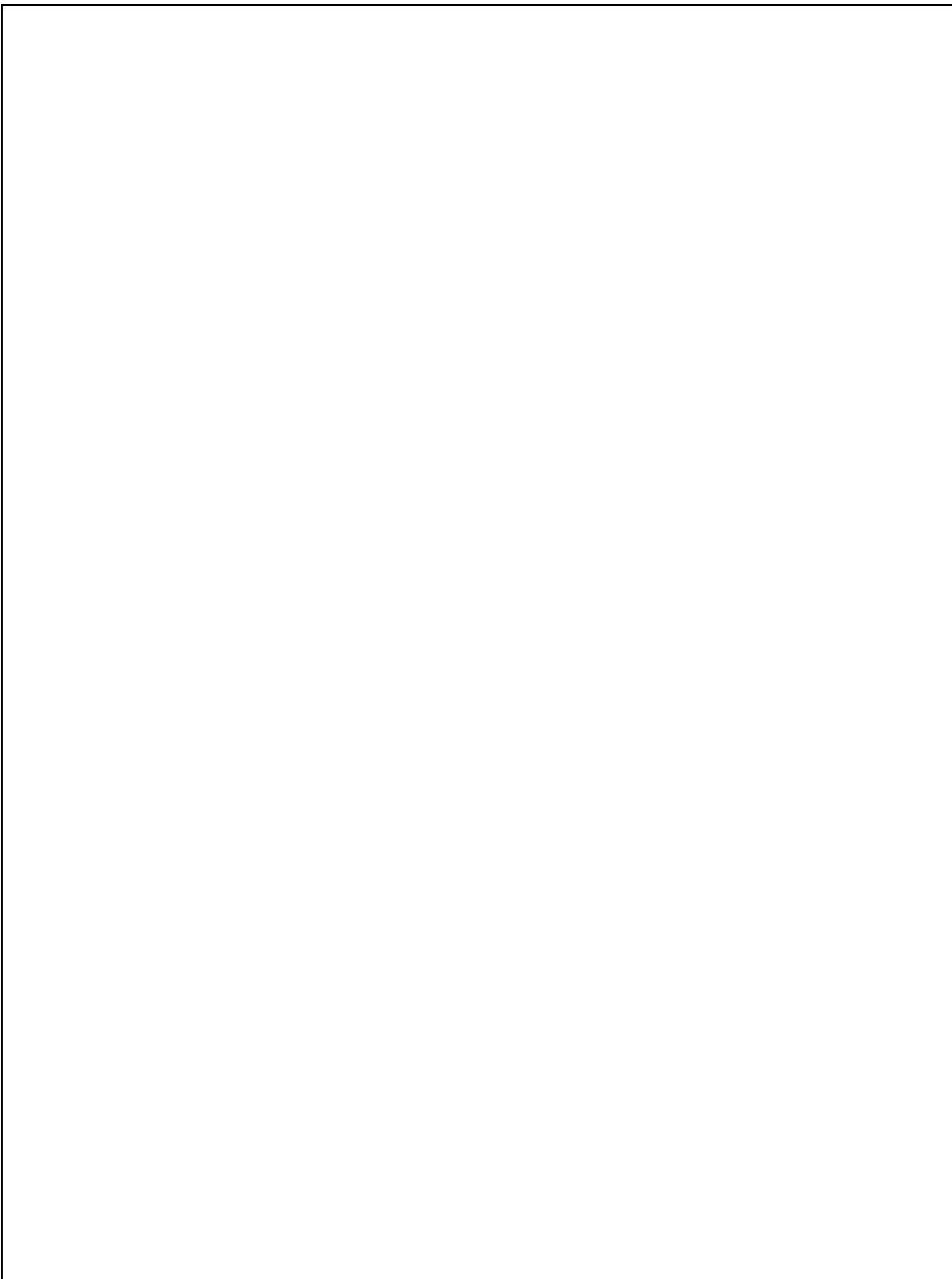

# onderdelencatalogus parts catalogue



groep/ group	blz./ page	type	omschrijving/description	datum/date
5	1a	P4.17 P4.19 P4.42	Vliegwielhuis Hurth Flywheel housing Hurth	7.7.99

pos.	qty	part	benaming	description
1	1	STM6398	Vliegwielhuis	Flywheel housing
2	1	STM4104	Demperplaat HBW, Volvo 110S, 120S, 120 SB	Damper plate HBW, Volvo 110S, 120S, 120 SB
	1	STM6396	Demperplaat 7.99 => HSW125-PRM150	Damper plate 7.99 => HSW125-PRM150
3	1	STM6505	Vliegwiel verzwaring	Flywheel ring
4	1	STM6521	Afdichtplaat	Cover
5	1	STM6520	Afdichtplaat	Cover
6	4	STM1025	Gegolfde veerring M6	Wave spring washer M6
7	4	STM1030	Bout M6x20	Bolt M6x20
8	6	STM1019	Gegolfde veerring M8	Wave spring washer M8
9	6	STM1610	Bout M8x25	Bolt M8x25
10	3	STM3452	Paspen 1/4"x5/8" ANSI B5.20	Pin 1/4"x5/8 ANSI B5.20
11	6	STM6539	Inbusbout M8x40	Allen Screw M8x40
12	3	STM6537	Paspen 6x20 DIN6325	Pin 6x20 DIN6325
13	6	STM1056	Veerring M8	Spring washer M8
14	6	STM6111	Inbusbout M8x16	Allen screw M8x16
15	4	STM4061	Gegolfde veerring M10	Wave spring washer M10
16	4	STM1612	Bout M10x100	Bolt M10x100
17	2	STM6611	Spanbus	Bush
18	2	STM6397	Steun	Support
19	4	STM4003	Veerring M12	Spring washer M12
20	4	STM8121	Bout M12x40	Bolt M12x40
21	4	STM4010	Moer M16x1,5	Nut M16x1.5
22	2	STM4011	Ring	Washer
23	2	KSTEUN75	Trillingdemper	Vibration damper
24	1	STM6560	Bout M10x50	Bolt M10x50
25	1	STM3453	Bus	Bush
26	1	STM8826	Bout M10x90	Bolt M10x90
27	1	STM4062	Bout M10x40	Bolt M10x40
28	3	STM4061	Gegolfde veerring M10	Wave spring washer M10

# onderdelencatalogus parts catalogue



groep/ group	blz./ page	type	omschrijving/description	datum/date
5	1a	P4.17 P4.19 P4.42	Vliegwielhuis Hurth Flywheel housing Hurth	7.7.99

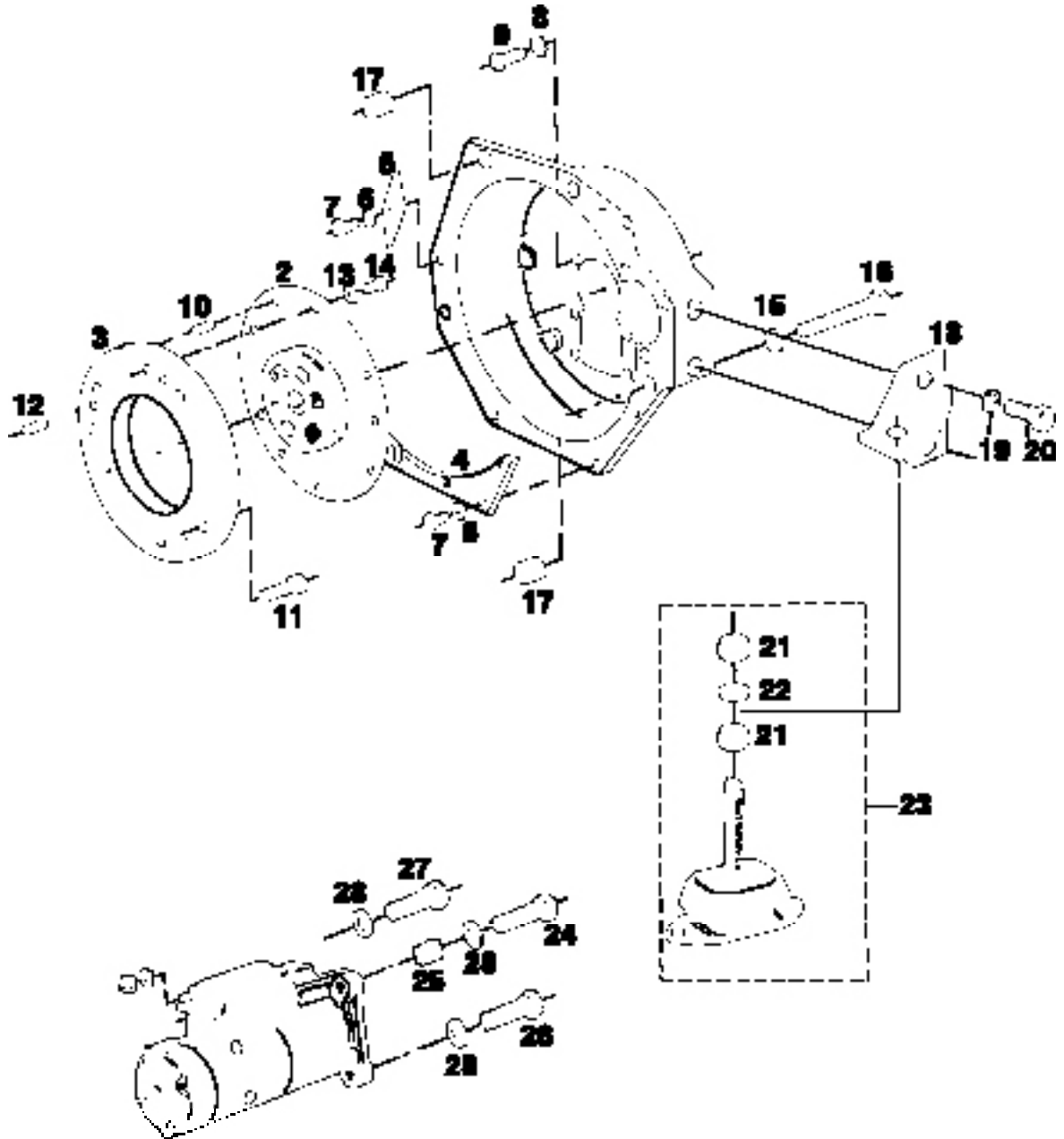

# onderdelencatalogus parts catalogue



groep/ group 5	blz./ page 2	type P4.17 P4.19 P4.42	omschrijving/description Vlieg wielhuis Velvet Flywheel housing Velvet	datum/date 26.1.94
----------------------	--------------------	------------------------------	--	-----------------------

pos.	qty	part	benaming	description
1	1	STM6519	Vlieg wielhuis Velvet	Flywheel housing Velvet
2	1	STM5021	Demperplaat Velvet	Damper plate Velvet
3	1	STM6505	Vlieg wiel verzwaring	Flywheel ring
4	1	STM6521	Afdichting	Cover
5	1	STM6520	Afdichting	Cover
6	4	STM1025	Gegolfde veerring M6	Wave spring washer M6
7	4	STM1030	Bout M6x20	Bolt M6x20
8	6	STM5028	Bout 7/16"UNCx 3 1/2"	Bolt 7/16"UNCx 3 1/2"
9	6	STM5018	Ring	Washer
10	3	STM3452	Paspen 1/4"x5/8"ANSI B5.20	Pin 1/4"x5/8" ANSI B5.20
11	6	STM6539	Inbusbout M8x40	Allen screw M8x40
12	3	STM6537	Paspen 6x20 DIN6325	Pin 6x20 DIN6325
13	6	STM1056	Ring	Washer
14	6	STM6111	Inbusbout M8x16	Allen screw M8x16
15	4	STM4061	Gegolfde veerring M10	Wave spring washer M10
16	4	STM1612	Bout M10x100	Bolt M10x100
17	1	STM1054	Type plaatje	Model plate
18	2	STM3528	Kerfnagel 3x5 DIN1476	Pin 3x5 DIN1476
19	2	STM6611	Spanbus	Busch
20	1	STM5179	Peilstok Velvet	Dipstick Velvet
21	4	STM4010	Moer M16x1,5	Nut M16x1.5
22	2	STM4011	Ring M16	Washer M16
23	2	KSTEUN75	Trillingdemper	Vibration damper
24	1	STM4053	Adaptorplaat HBW	Adapterplate HBW
25	6	STM5017	Bout 7/16"UNCx 1 1/4"	Bolt 7/16"UNCx 1 1/4"
26	6	STM5018	Ring	Washer
27	6	STM1610	Bout M8x25	Bolt M8x25
28	6	STM1019	Gegolfde veerring M8	Wave spring washer M8
29	2	STM6052	Motorsteun	Engine support
30	4	STM4060	Bout M12x1,25x35	Bolt M12x1.25x35
31	4	STM4056	Gegolfde veerring M12	Wave spring washer M12
32	4	STM4058	Moer M12x1,25	Nut M12x1.25
33	1	STM5206	Keerkop.Velvet 1,52 71C 006	Gearbox Velvet 1.52 71C 006
	1	STM5208	Keerkop.Velvet 1,91 71C 008	Gearbox Velvet 1.91 71C 008
	1	STM5210	Keerkop.Velvet 2,1 71C 010	Gearbox Velvet 2.1 71C 010
	1	STM5212	Keerkop.Velvet 2,57 71C 012	Gearbox Velvet 2.57 71C 012
	1	STM5214	Keerkop.Velvet 2,91 71C 014	Gearbox Velvet 2.91 71C 014
34	2	STM5016	Steun	Support
35	4	STM5015	Ring	Washer
36	4	STM5014	Bout 7/16"UNCx 1 3/4"	Bolt 7/16"UNCx 1 3/4"



onderdelencatalogus  
parts catalogue



groep/ group	blz./ page	type	omschrijving/description	datum/date
-----------------	---------------	------	--------------------------	------------

--	--	--	--	--

# onderdelencatalogus parts catalogue



groep/ group	blz./ page	type	omschrijving/description	datum/date
5	3	P4.17 P4.19 P4.42	Oliekoeler PRM-Velvet Oilcooler PRM-Velvet	20.6.98

pos.	qty	part	benaming	description
1	1	STM5007	Oliekoeler 7"x ø55-G3/8 slingaansluiting ø25	Oilcooler 7"x_55-G3/8 Connection for hose ø25
1	1	STM3782	Oliekoeler kielkoeling 7"x ø55-G3/8 slingaansluiting ø42	Oilcooler for keelcooler 7"x ø55-G3/8 connection for hose ø42
2	1	CT30061	Klem	Clamp
3	1	STM6428	Slang	Hose
4	2	STM3005	Slangklem	Hose clamp
5	1	STM7014	Slangpilaar G3/4-25	Hose pilar G3/4-25
6	1	STM6557	Afdichtring M27	Sealwasher M27
7	2	STM3491	Nippel G3/8-M16	Nipple G3/8-M16
8	2	CT50079	Slang l=0,5mtr.	Hose l=0.5mtr.
9	2	STM3766	Nippel G1/4-M16 PRM	Nipple G1/4-M16 PRM
	2	STM3491	Nippel G3/8-M16 Velvet	Nipple G3/8-M16 Velvet
10	2	STM5009	Knie G3/8 Velvet	Knie G3/8 Velvet

onderdelencatalogus  
parts catalogue



groep/ group	blz./ page	type	omschrijving/description	datum/date
-----------------	---------------	------	--------------------------	------------

--	--	--	--	--

# onderdelencatalogus parts catalogue



groep/ group 6	blz./ page 1	type P4.17 P4.19	omschrijving/description Brandstofsysteem Fuel System	datum/date 07.02.'01
----------------------	--------------------	------------------------	---	-------------------------

pos.	qty	part	benaming	description
1	1	STM6864	Tandwiel	Pinion
2	1	STM6865	Moer	Nut
3	1	STM6866	Flens	Flange
4	2	STM6868	Sluitring ø 7	Washer ø 7
5	2	STM6493	Bout M7 x 100-25	Bolt M7 x 100-25
7	1	STM6869	Kabelsteun	Support
8	1	STM6870	Brandstofpomp DPC Lucas (Rotodiesel)	Fuel pump DPC Lucas (Rotodiesel)
9	1	STM6569	Veer	Spring
10	1	STM6871	Verstuiverleidingen	Injection pipe
11	1	STM6872	Dop	Plug
12	3	STM6873	Lekolie leiding	Oil Drain Pipe
13	1	STM6874	Klem	Cramp
14	1	STM6875	Lekolie leiding pomp	Oil Drainage Pump
15	4	STM6876	Verstuiver compleet	Injector Complete
16	4	STM6877	Verstuiver	Injector
17	4	STM6878	Dichting	Gasket
18	4	STM6879	Sproeier	Injector
19	4	STM6880	Bus	Bush
20	4	STM6881	Brandplaatje	Washer
21	1	STM6882	Retourleiding	Return pipe
22	2	STM6883	Ring	Washer
23	1	STM6884	Banjo Oog	Banjo Eye
24	2	STM6885	Ring	Washer
25	2	STM6491	Banjo Bout	Banjo Bolt

onderdelencatalogus  
parts catalogue



groep/ group	blz./ page	type	omschrijving/description	datum/date
-----------------	---------------	------	--------------------------	------------

--	--	--	--	--

# onderdelencatalogus parts catalogue



groep/ group	blz./ page	type	omschrijving/description	datum/date
10	1		Showbok Engine display	6.4.00

pos.	qty	part	benaming	description	
1	1	STM9234	RVS showbok	S.S.display	GHS6/8
	1	STM9235	RVS showbok	S.S.display	GLS6/15
	1	STM9239	RVS showbok	S.S.display	GHS4
2	8	STM4016	Ring M10	Washer M8	
3	8	STM8390	Bout M10x20	Bolt M10x20	
4	1	STM9228	RVS showbok	S.S.display	M2.04
	1	STM9229	RVS showbok	S.S.display	M2.06
	1	STM9236	RVS showbok	S.S.display	M2.06/110S 120SB
	1	STM9230	RVS showbok	S.S.display	M3.10
	1	STM9231	RVS showbok	S.S.display	M4.14
	1	STM9232	RVS showbok	S.S.display	P4.17/19/42
	1	STM9233	RVS showbok	S.S.display	P4.25
	1	STM9237	RVS showbok	S.S.display	M4.15/M4.17
	1	STM9238	RVS showbok	S.S display	M3.09
5	8	STM3355	Bout M8x20	Bolt M8x20	M2.04
	8	STM4016	Bout M10x20	Bolt M10x20	
6	8	CT30059	Ring M8	Washer M8	M2.04
	8	STM8390	Ring M10	Washer M10	
7	8	STM1056	Veerring M8	Spring washer M8	M2.04
		STM4014	Veerring M10	Spring washer M10	
8	8	STM2005	Moer M8	Nut M8	M2.04
	8	STM4018	Moer M10	Nut M10	

onderdelencatalogus  
parts catalogue



groep/ group	blz./ page	type	omschrijving/description	datum/date
-----------------	---------------	------	--------------------------	------------

--	--	--	--	--

# ***vetus diesel b.v.***

FOKKERSTRAAT 571 - 3125 BD SCHIEDAM - HOLLAND - TEL.: +31 (10) 4377700  
FAX: +31 (10) 4621286 - 4373474 - 4153249 - 4372673 - E-MAIL: DIESEL@VETUS.NL